

Silicon Schottky Diodes

Preliminary data

- For low-loss, fast-recovery, meter protection, bias isolation and clamping applications
- Integrated diffused guard ring
- Low forward voltage

Pin Configuration

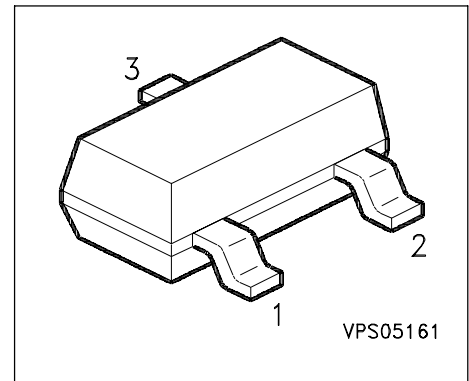

BAT 64-04

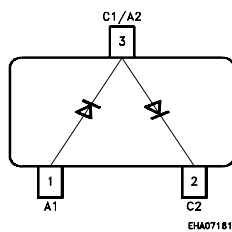

BAT64-05

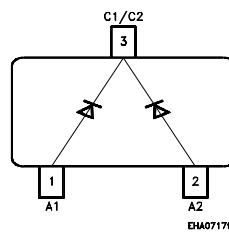

BAT64-06

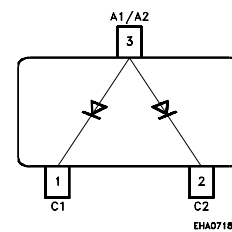

ESD: ElectroStatic Discharge sensitive device, observe handling precautions!

Type	Marking	Ordering Code	Pin Configuration			Package
BAT 64	63s	Q62702-A879	1 = A		3 = C	SOT-23
BAT 64-04	64s	Q62702-A961	1 = A	2 = C	3 = C/A	SOT-23
BAT 64-05	65s	Q62702-A962	1 = A	2 = A	3 = C/C	SOT-23
BAT 64-06	66s	Q62702-A963	1 = C	2 = C	3 = A/A	SOT-23

Maximum Ratings

Parameter	Symbol	Values	Unit
Diode reverse voltage	V_R	40	V
Forward current	I_F	250	mA
Average forward current (50/60Hz, sinus)	I_{FAV}	120	
Surge forward current ($t \leq 10ms$)	I_{FSM}	800	
Total Power dissipation $T_S = 61 \text{ }^\circ\text{C}$	P_{tot}	250	mW
Junction temperature	T_j	150	$^\circ\text{C}$
Storage temperature	T_{stg}	- 55 ... + 150	

Thermal Resistance

Junction ambient ¹⁾	R_{thJA}	≤ 495	K/W
Junction - soldering point	R_{thJS}	≤ 355	

1) Package mounted on epoxy pcb 40mm x 40mm x 1.5mm / 0.5cm² Cu

Electrical Characteristics at $T_A=25^\circ\text{C}$, unless otherwise specified

Parameter	Symbol	Values			Unit
		min.	typ.	max.	
DC characteristics					
Reverse current $V_R = 25\text{ V}, T_A = 25^\circ\text{C}$ $V_R = 25\text{ V}, T_A = 85^\circ\text{C}$	I_R	-	-	2 200	μA
Forward voltage $I_F = 1\text{ mA}$ $I_F = 10\text{ mA}$ $I_F = 30\text{ mA}$ $I_F = 100\text{ mA}$	V_F	-	320 385 440 570	350 430 520 750	mV V
AC Characteristics					
Diode capacitance $V_R = 1\text{ V}, f = 1\text{ MHz}$	C_T	-	4	6	pF

Forward Current $I_F = f(V_F)$

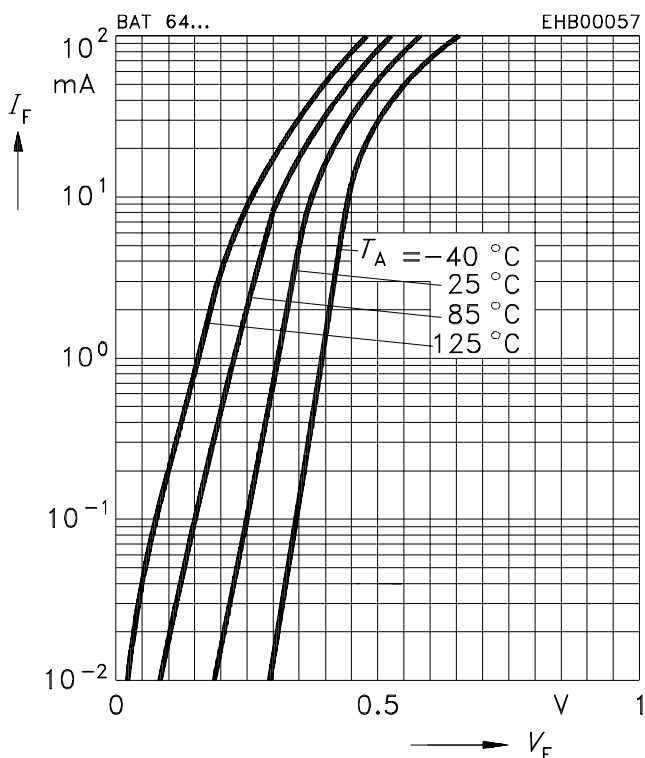

Reverse current $I_R = f(V_R)$

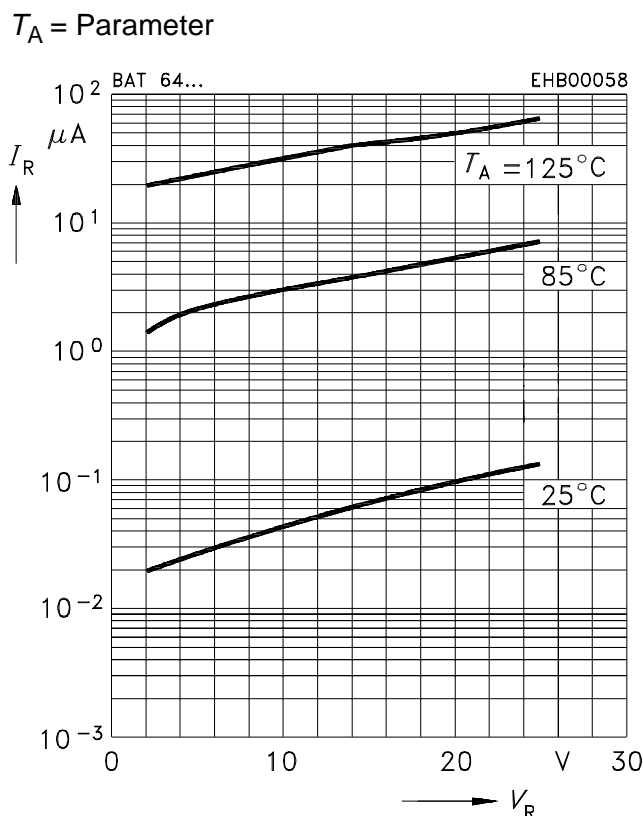

Diode capacitance $C_T = f(V_R)$

$f = 1\text{MHz}$

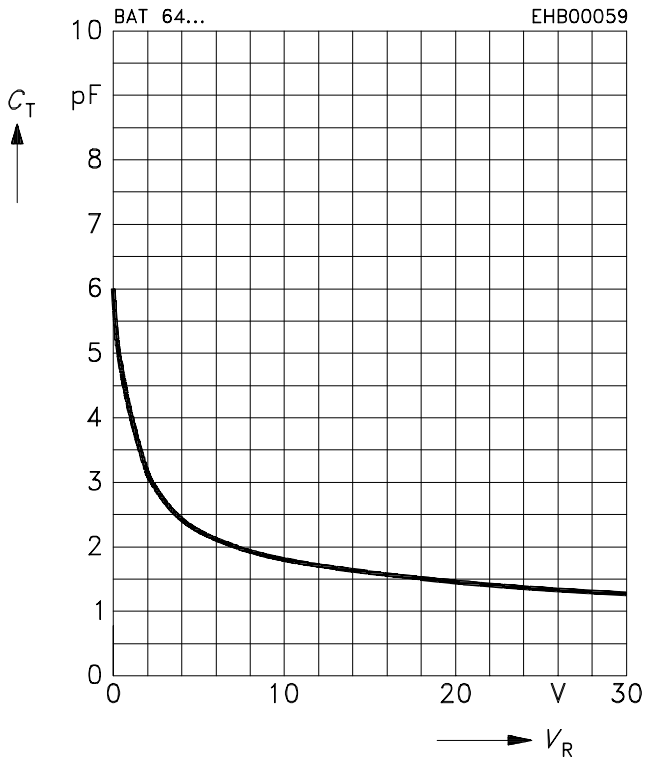

Forward current $I_F = f(T_A^*; T_S)$

* Package mounted on epoxy

BAT 64

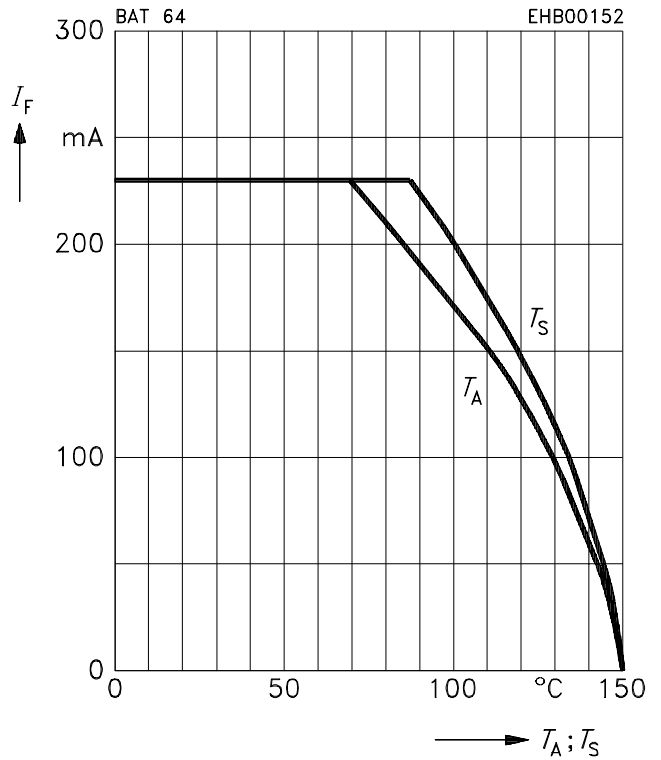

Forward current $I_F = f(T_A^*; T_S)$

* Package mounted on epoxy

BAT 64-04... (I_F per diode)

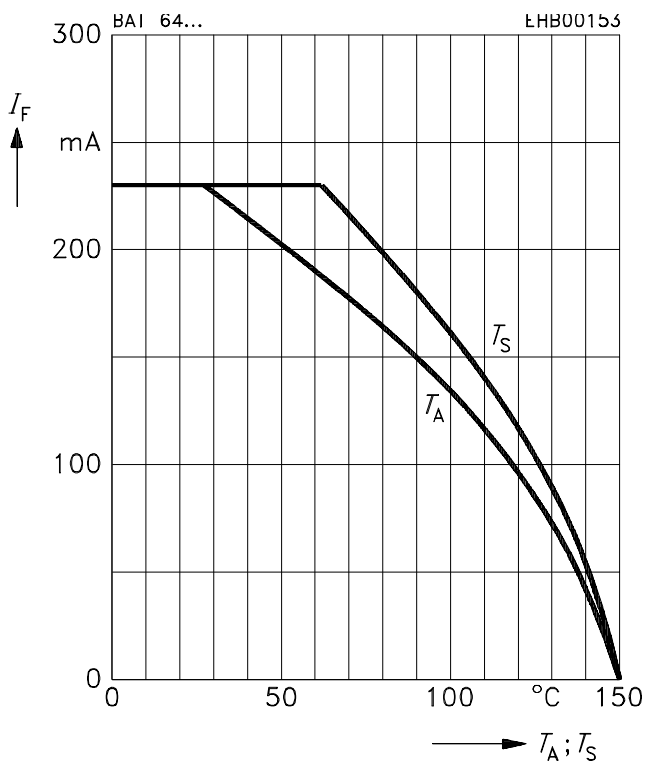

This datasheet has been download from:

www.datasheetcatalog.com

Datasheets for electronics components.